

**Tower Crane / Grue à tour / Gru a torre  
Grúa torre / Guindaste de torre**

# Turmdrehkran 112 EC-B 8

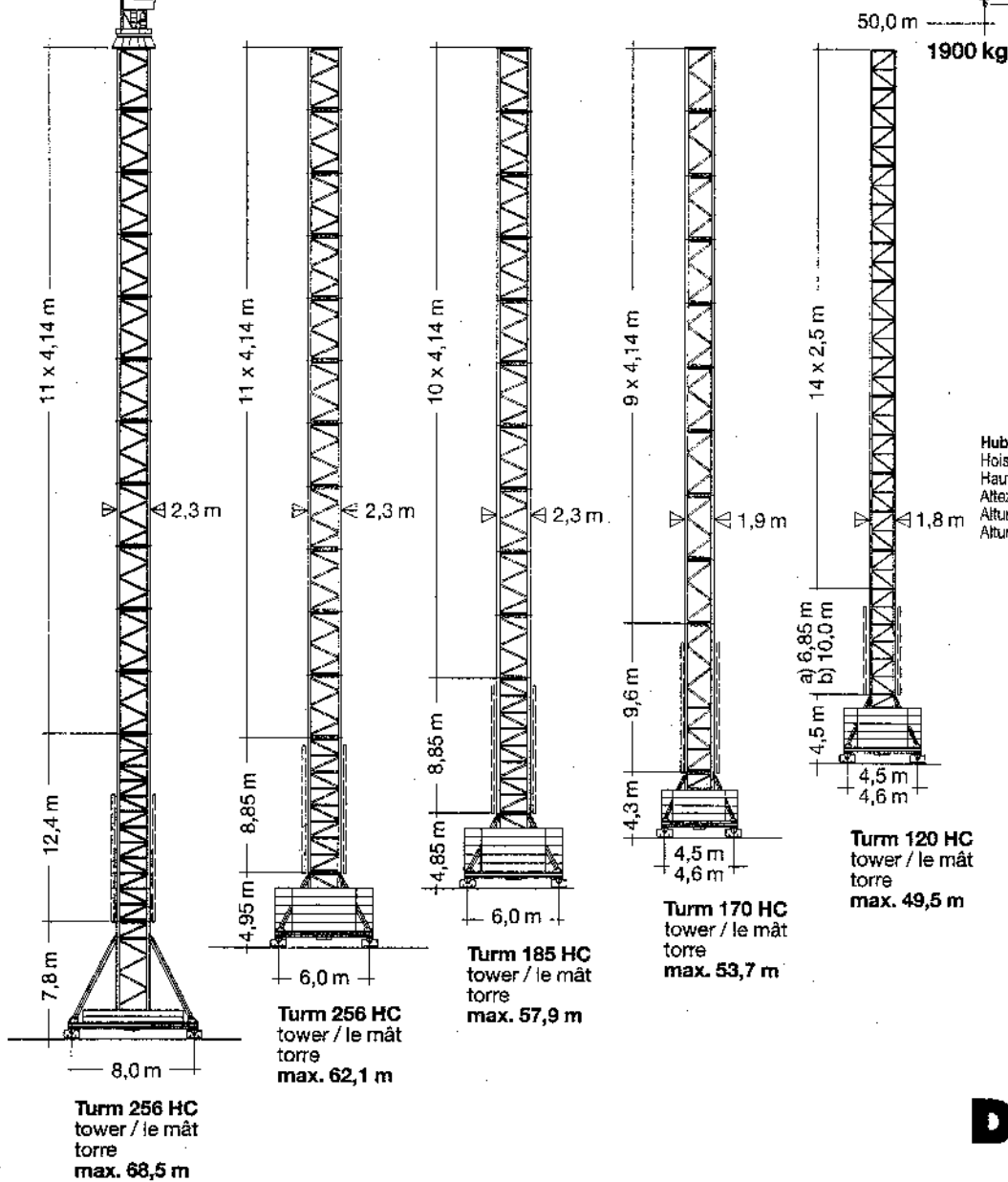
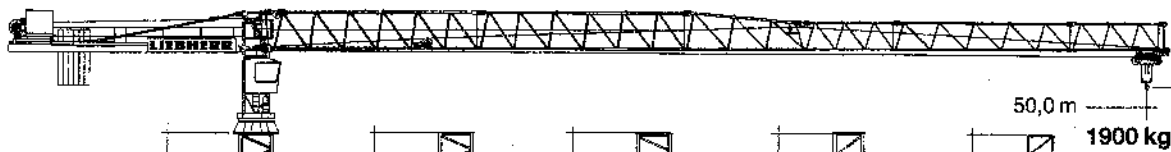

**DIN/FEM**

1:480

# LIEBHERR

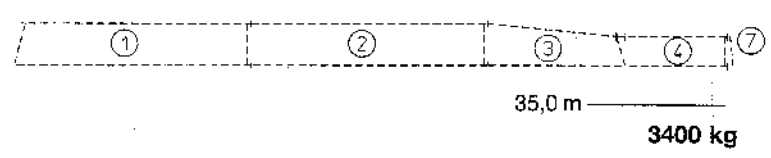
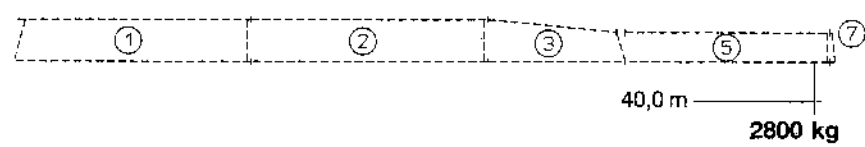
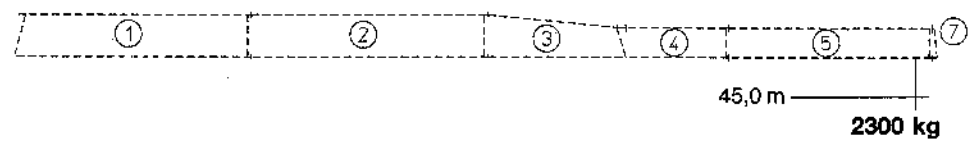
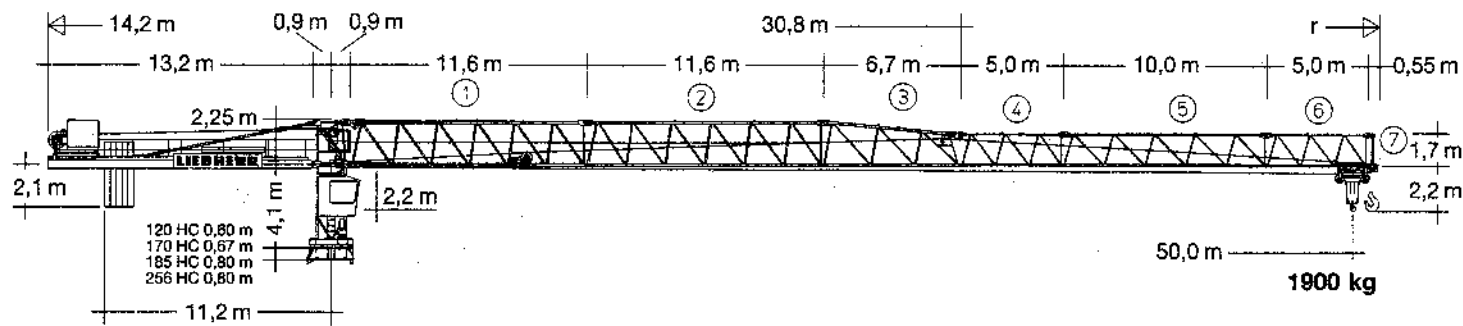

# Hubhöhe

Hoisting height / Hauteur sous crochet / Altezza di sollevamento / Altura bajo gancho / Altura de montagem

		120 HC															
		m		m		m 47,1*		m		m		m		m		m	
15		-	-	-	-	-	-	-	-	-	-	-	-	-	-	-	-
14		48,9*	-	48,4*	-	44,6*	-	-	-	-	-	47,3*	-	46,8*	-	-	-
13		46,4	49,5*	45,9	49,0*	42,1	45,2*	43,6*	-	-	-	44,8	-	44,3	-	-	-
12		43,9	47,0*	42,4	46,5	39,6	42,7*	41,1*	44,2*	40,9*	44,0*	42,3	45,4*	41,8	44,9*	-	-
11		41,4	44,5	40,9	44,0	37,1	40,2	38,6	41,7*	38,4	41,5*	39,8	42,9	39,3	42,4	-	-
10		38,9	42,0	38,4	41,5	34,6	37,7	36,1	39,2	35,9	39,0	37,3	40,4	36,8	39,9	-	-
9		36,4	39,5	35,9	39,0	32,1	35,2	33,6	36,7	33,4	36,5	34,8	37,9	34,3	37,4	-	-
8		33,9	37,0	33,4	36,5	29,6	32,7	31,1	34,2	30,9	34,0	32,3	35,4	31,8	34,9	-	-
7		31,4	34,5	30,9	34,0	27,1	30,2	28,6	31,7	28,4	31,5	29,8	32,9	29,3	32,4	-	-
6		28,9	32,0	28,4	31,5	24,6	27,7	26,1	29,2	25,9	29,0	27,3	30,4	26,8	29,9	-	-
5		26,4	29,5	25,9	29,0	22,1	25,2	23,6	26,7	23,4	26,5	24,8	27,9	24,3	27,4	-	-
4		23,9	27,0	22,4	26,5	19,6	22,7	21,1	24,2	20,9	24,0	22,3	25,4	21,8	24,9	-	-
3		21,4	24,5	20,9	24,0	17,1	20,2	18,6	21,7	18,4	21,5	19,8	22,9	19,3	22,4	-	-
2		18,9	22,0	18,4	21,5	14,6	17,7	16,1	19,2	15,9	19,0	17,3	20,4	16,8	19,9	-	-
1		16,4	19,5	15,9	19,0	12,1	15,2	13,6	16,7	13,4	16,7	14,8	17,9	14,3	17,4	-	-
0		a) 13,9 b) 17,0		a) 13,4 b) 16,5		a) 9,6 b) 12,7		a) 11,1 b) 14,2		a) 10,9 b) 14,0		a) 12,3 b) 15,4		a) 11,8 b) 14,9			

Unterwagen: ① fahrbar, ② stationär. ③ Fundamentanker. Fundamentkreuz: ① fahrbar, ② stationär. Unterwagen klappbar: ① fahrbar, ② stationär.  
 Undercarriage: ① rail-going, ② stationary. ③ Foundation anchors. Cruciform base: ① rail-going, ② stationary. Hinged undercarriage: ① rail-going, ② stationary.  
 Châssis: ① mobile, ② stationnaire. ③ Pieds de scellement. Châssis en croix: ① mobile, ② stationnaire. Châssis articulé: ① mobile, ② stationnaire.  
 Carro: ① traslante, ② stazionario. Tirafondi. Crociera di fondazione: ① traslante, ② stazionario. Carro ripiegabile: ① traslante, ② stazionario.  
 Carretón: ① móvil, ② estacionaria. Pies de anclaje. Base cruciforme: ① móvil, ② estacionaria. Carretón articulado: ① móvil, ② estacionaria.  
 Chassis: ① Móvel, ② Estacionária. Pés de ancoragem. Base cruciforme: ① Móvel, ② Estacionária. Chassis articulado: ① Móvel, ② Estacionária.

# 112 EC-B 8

# Ausladung und Tragfähigkeit



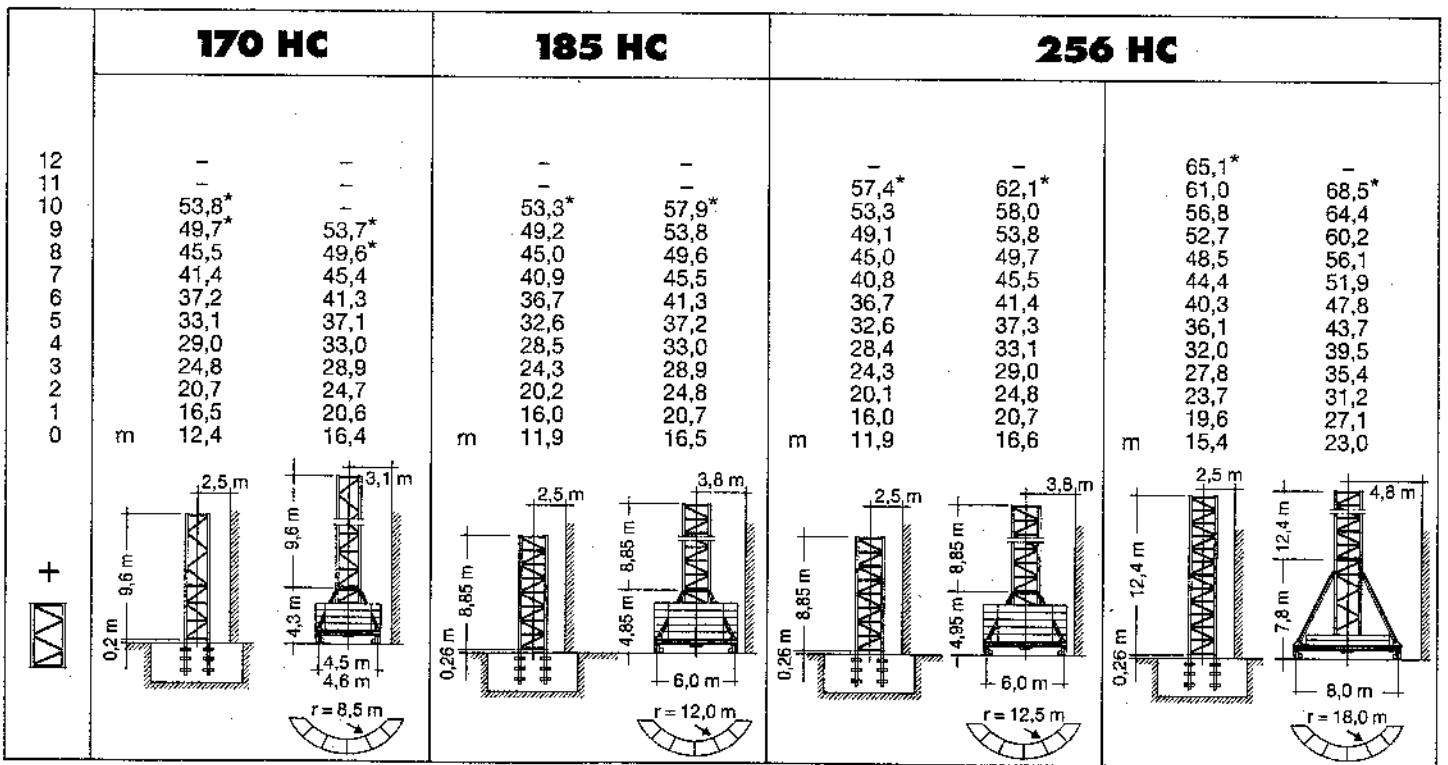
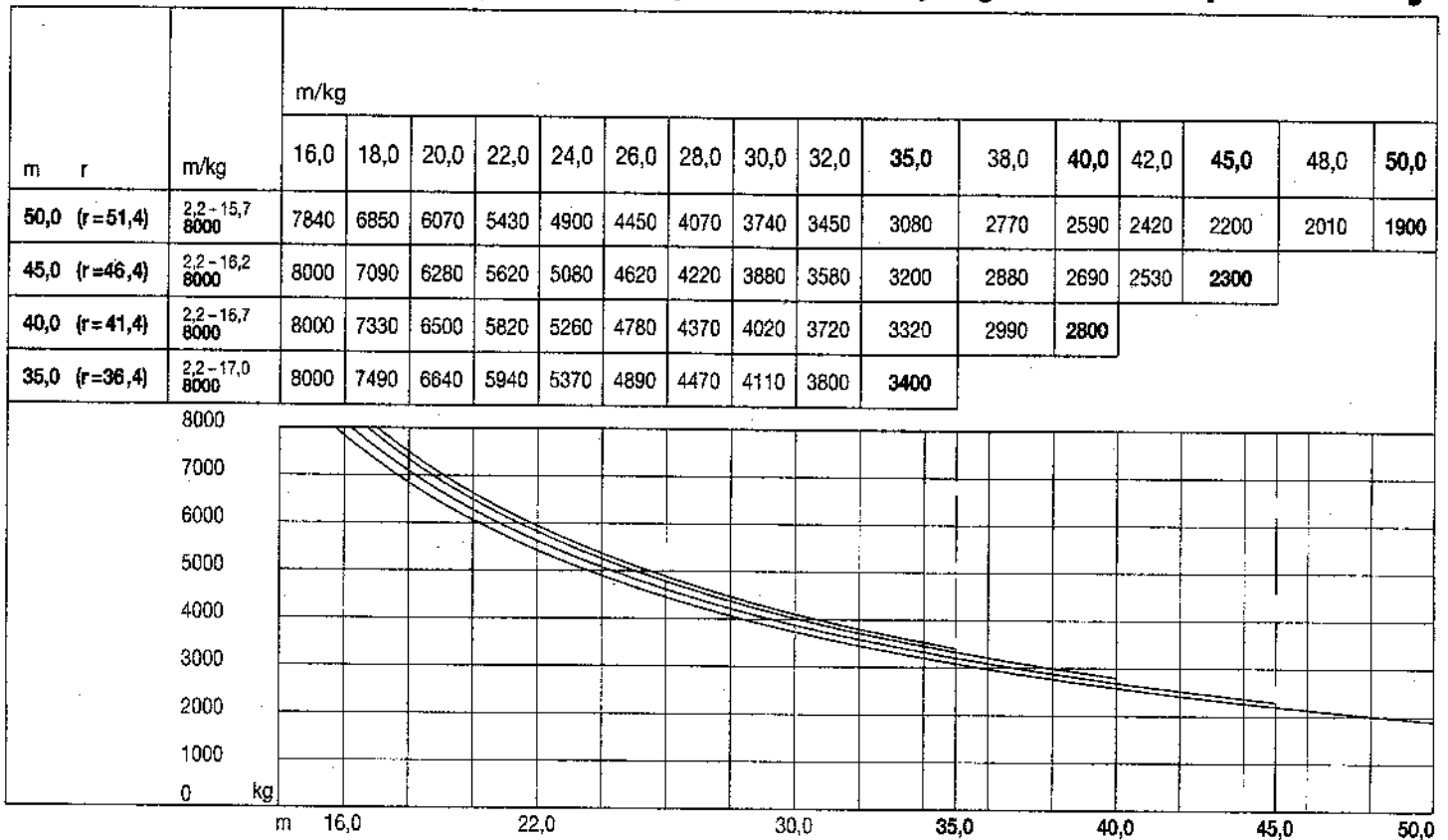

Radius and capacity / Portée et charge / Sbraccio e portata / Alcances y cargas / Alcance e capacidade de carga



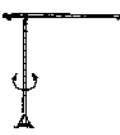

\* Weitere Hubhöhen sowie Klettern im Gebäude auf Anfrage. / Further hoist heights and climbing in the building on request.  
 Hauteurs sous crochet plus élevées et hissage dans le bâtiment sur demande. / Altre altezze di sollevamento come pure varianti di gru allungabili: su richiesta. / Para alturas bajo gancho superiores y trepado en el interior del edificio, consultar. / Outras alturas de elevação e subida no edificio: conforme ao pedido.

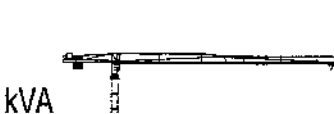
# Geschwindigkeiten

Speeds / Vitesse / Velocità / Velocidades / Velocidades

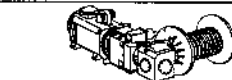
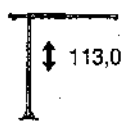
	U/min 0 ↔ 0,8 st./min tr./min	1 x 6,3 kW
	0 ↔ 100,0 m/min	5,5 kW, FU
	25,0 m/min	2 x 3,0 kW 120 HC (132 HC) 2 x 7,5 kW 256 HC (290 HC) 2 x 5,5 kW (185 HC, 170 HC)
 kVA		30 kW 30 kW, FU 37 kW, FU 68,0 45,0 50,0

	Gang / Gear / Rapport Marcia / Velocidad Velocidade	kg	m/min
30,0 / 25,0 / 6,2 kW, Elmag WIW 240 RX 036			
 113,0 m	5 Lagen Layers Couches strati camadas capas	8000	3,4
	1	8000	15,0
		4600	30,0
		3100	8,0
	2	3100	36,0
		1800	71,0

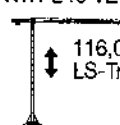
	↔ stufenlos / stepless / régl. continu regl. progressiva / sin escalones Sem degraus	kg	m/min
30,0 kW, FU WIW 240 VZ 402	4 Lagen Layers Couches strati camadas capas	<b>1</b> 8000 0 ↔ 19 1800 0 ↔ 68	
 116,0 m LS-Trommel		<b>2</b> 4600 0 ↔ 32 800 0 ↔ 120	

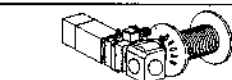
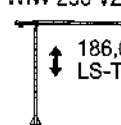
	↔ stufenlos / stepless / régl. continu regl. progressiva / sin escalones Sem degraus	kg	m/min
37,0 kW, FU WIW 250 VZ 401	6 Lagen Layers Couches strati camadas capas	<b>1</b> 8000 0 ↔ 24 1800 0 ↔ 80	
 186,0 m LS-Trommel		<b>2</b> 4600 0 ↔ 40 800 0 ↔ 140	

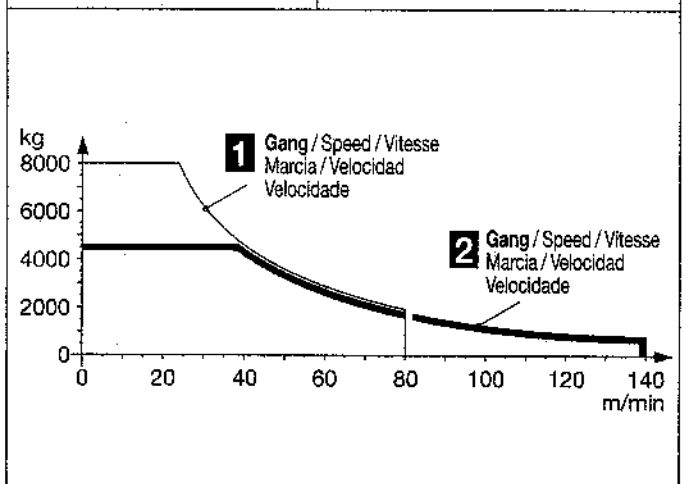
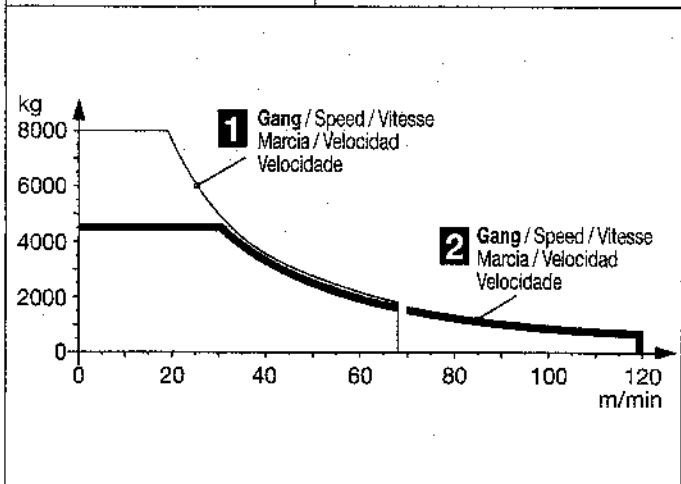

Weitere Elmag-Hubwerke: siehe Broschüre „Zusätzliche Hubwerksvarianten“ / Further hoist gears: see brochure „Additional hoist gear variants“ / Autres mécanismes de levage: voir brochure „Variantes supplémentaires du mécanisme de levage“ / Ulteriori argani ad innesto elettromagnetico: vedere prospetto „argani alternativi“ / Otros mecanismos de elevación de Elmag: Ver folleto „Mecanismos de elevación adicionales“ / Outros mecanismos de elevação de ELMAG: Ver Folheto „Mecanismos de elevação adicionais“

# Technische Daten

Technical data - Caractéristiques techniques













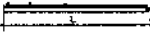

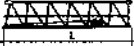

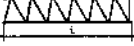

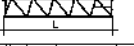

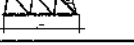

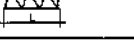
Caratteristiche tecniche - Características técnicas - Datos técnicos

# Kolli-Liste







Packing List / Liste de colisage / Lista dei colli  
Lista de contenido / Lista de embalagem

Montagegewichte: siehe Betriebsanweisung.  
Erection weights: see instruction manual.  
Poids de montage: voir manuel de service.  
Pesi di montaggio: vedasi le istruzioni sull'uso.  
Pesos de montagem: vejam-se as instruções p. uso.  
Peso para el montaje: según manual.



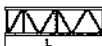

## Kranoberteil Upper part of crane / Partie supérieure de gru Parte superiore della gru / Parte superior grúa Parte superior do guindaste

Pos. Item Rep. Voce Pos. Ref.	Anz. Qty. Cant. Cant.				L (m)	B (m)	H (m)	kg	
1	1	Drehbühne kpl. / Slewing platform cpl. Ensemble mât cabine cpl. / Piattaforma girevole compl. / Conjunto plataforma de giro / Plataforma giratória compl.			120 HC (132 HC) 170 HC 185 HC (200 HC) 256 HC (290 HC)	7,14 7,58 7,58	2,30 2,74 2,74	2,50 2,66 2,66	8300 8950 9000 9000
2	1	Gegenausleger / Counter-jib Contre-flèche / Controbraccio Contrapluma / Contra-lança				13,23	2,42	0,91	3940
3	1	Ausleger-Anlenkstück / Jib heel section Pied de flèche / Settore articolato di braccio Base articulada de lança / Pluma tramo primero				11,87	1,70	2,37	⊙ 2870
4	4	Ausleger-Zwischenstück / Intermediate jib section Élément interm. de flèche / Spezzione di braccio Peça suplementar da lança / Tramo intermedio pluma				11,88	1,50	2,25	⊙ 1740
5	4	Ausleger-Zwischenstück / Intermediate jib section Élément interm. de flèche / Spezzione di braccio Peça suplementar da lança / Tramo intermedio pluma				10,31	1,50	1,68	⊙ 730
6	2	Ausleger-Zwischenstück / Intermediate jib section Élément interm. de flèche / Spezzione di braccio Peça suplementar da lança / Tramo intermedio pluma				6,90	1,50	2,25	⊙ 810
7	2	Ausleger-Zwischenstück / Intermediate jib section Élément interm. de flèche / Spezzione di braccio Peça suplementar da lança / Tramo intermedio pluma				5,31	1,50	1,68	⊙ 530 ⊙ 320
8	1	Ausleger-Kopfstück / Jib head Pointe de flèche / Punta freccia Cabeça de lança / Tramo punta de pluma				0,62	1,73	1,88	⊙ 150
9	1	Laufkatze und Lasthaken / Trolley and hook Chariot de distribution et crochet / Carrello con gancio Carrito y gancho / Carro de ponte e gancho				1,82	1,69	1,44	860
10	1	Hubwerksinheit / Hoist gear unit / Treuil de levage Gruppo meccanismo sollevamento / Mecanismo de elevación / Grupo de mecanismo elevatório			W/W 280 MW 406	2,70	2,30	1,70	2750
11	1	Gegenausleger mit Hubwerksinheit 45 kW Counter-jib with hoist gear unit / Contre-flèche avec treuil de levage / Controbraccio con gruppo meccanismo sollevamento / Contra-pluma con mecanismo de elevación / Contra-lança com grupo de mecanismo elevatório				13,23	2,42	2,44	8300



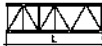

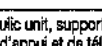

## Turm Tower / Mât / Torre Torre / Torre

12	14 9 10 11	Turmstück / Tower section Element de mât / Elemento di torre Torre / Torre			120 HC (132 HC) 170 HC 185 HC (200 HC) 256 HC (290 HC)	2,50 4,14 4,14 4,14	1,80 1,90 2,30 2,30	1,80 1,90 2,30 2,30	1050 1850 2050 2260
13	7 3	Turmstück lang / Long tower section Élément de mât long / Elemento di torre, lungo Tramo de torre largo / Peça de torre, comprida			120 HC (132 HC) 120 HC (132 HC) 120 HC (132 HC)	5,0 10,0 12,5	1,80 1,80 1,80	1,80 1,80 1,80	1960 3400 4200
14	1	Grundturmstück / Base tower section Mât de base / Elemento di torre base Tramo torre base / Peça de base de torre			120 HC (132 HC) 120 HC (132 HC) 170 HC 185 HC (200 HC) 256 HC (290 HC)	6,85 10,00 9,60 8,85 8,85	1,80 1,80 1,90 2,30 2,30	1,80 1,80 1,90 2,30 2,30	2560 3420 4350 4100 4580 (7700)

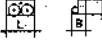
## Klettereinrichtung Climbing equipment / Equipement de télescage / Attrezzatura per allungamento della gru Equip de trepado / Acessórios p. subida no edifício

15	1	Führungstück kpl. / Guide section cpl. / Cage télescopique cpl. / Gabbia di sopraelevazione compl. / Peça de guia compl. / Torre de montaje completa			120 HC (132 HC) 120 HC (132 HC) 170 HC 185 HC (200 HC) 256 HC (290 HC)	6,45 9,60 9,04 8,39 8,39	2,10 2,10 2,31 2,80 2,80	2,42 2,42 2,28 2,50 2,50	2660 4410 4750 5100 5100
16	1	Hydraulikanlage, Stütz- und Klettertraverse / Hydraulic unit, supporting and climbing cross members / Système hydraulique avec traverses d'appui et de télescage / Sistema hidráulico, travessa di appoggio e allungamento gru / Instalação hidráulica, travessa de apoio e subida / Sistema hidráulico con travessa de apoyo y trepado			120 HC (132 HC) 170 HC 185 HC (200 HC) 256 HC (290 HC)	2,87 2,00 2,30 2,30	2,12 1,10 1,25 1,25	1,06 1,00 1,00 1,00	1050 1100 1150 1150

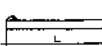
## Unterwagen Undercarriage / Châssis / Carro della gru Carro con mástil / Carro de guindaste

17	2	Fahrschemel mit Antrieb / Rail bogie with drive Bogie moteur / Telaio con gruppo propulsore Quadro sem grupo de propulsão / Caja rodillo motriz			120 HC (132 HC) 170 HC 185 HC (200 HC) 256 HC (290 HC)	1,38 1,46 1,46 1,63 (1,46)	0,88 0,84 0,84 0,92 (0,84)	0,87 0,87 0,87 0,95 (0,87)	900 920 920 1690 (920)
18	2	Fahrschemel ohne Antrieb / Rail bogie without drive / Bogue fou / Telaio senza gruppo propulsore / Quadro com grupo de propulsão Caja-rodillo conducido			120 HC (132 HC) 170 HC 185 HC (200 HC) 256 HC (290 HC)	1,17 1,15 1,15 1,37 (1,15)	0,60 0,60 0,60 0,62 (0,60)	0,87 0,87 0,87 0,95 (0,87)	860 880 880 1340 (880)
19	1	Tragholm lang / Long support arm Longeron long / Longherone lungo Braço largo soporte / Travessa comprida			120 HC (132 HC) 170 HC 185 HC (200 HC) 256 HC (290 HC)	7,12 7,15 9,10 9,10 (11,95)	0,78 0,80 0,82 0,80 (0,82)	0,65 0,70 0,74 0,80 (0,80)	950 1070 1350 1650 (2200)

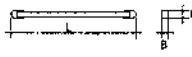
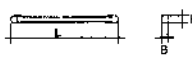
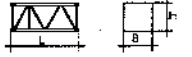
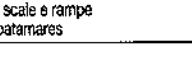
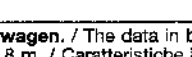
Pos. Item Rep. Voce Pos. Ref.	Anz. Qty. Cts. Cant. Cant.				L (m)	B (m)	H (m)	kg	Einzelgewichte / Single weights / Poids individuels. Pesi et equipamenti. Pesos de peças componentes. Pesos utilizados.
20	2	Tragholm kurz / Short support arm Longeron court / Longherone corto Braço corto soporte / Travessa curta		120 HC (132 HC)	3,45	0,56	0,55	408	
				170 HC	3,45	0,60	0,70	500	
				185 HC (200 HC)	4,41	0,62	0,71	615	
				256 HC (290 HC)	4,45 (5,56)	0,77 (0,65)	0,77 (0,77)	800 (1035)	
21	2 + 2	Randträger / Border support Traverse / Supporti base Travessa / Apoio de bordo		120 HC (132 HC)	4,02	0,35	0,12	95	
				170 HC	4,08 - 4,30	0,16 - 0,33	0,11 - 0,14	80 - 200	
				185 HC (200 HC)	5,48 - 5,46	0,11 - 0,17	0,16 - 0,38	118 - 454	
				256 HC (290 HC)	5,46 - 5,40 (7,52 - 7,46)	0,11 - 0,18 (0,1 - 0,17)	0,16 - 0,38 (0,1 - 0,38)	175 - 525 (366 - 912)	
22	4	Stützholm / Support strut Haube de châssis / Correnti di appoggio Tirante vertical / Travessa de apoio		120 HC (132 HC)	3,78	0,15	0,22	200	
				170 HC	3,53	0,25	0,17	240	
				185 HC (200 HC)	4,23	0,17	0,25	275	
				256 HC (290 HC)	4,14 (6,55)	0,18 (0,22)	0,25 (0,25)	320 (600)	
23	1	Untwagen-Turmstück / Undercarriage tower section / Mât de châssis / Elemento di torre del carro / Tramo de carro / Peça de torre do chassis		120 HC (132 HC)	3,50	2,06	2,06	1320	
				170 HC	3,30	2,15	2,15	2000	
				185 HC (200 HC)	3,73	2,52	2,52	1950	
				256 HC (290 HC)	3,73 (6,70)	2,62 (2,53)	2,62 (2,53)	2550 (3800)	
24	1	Stapel Aufstiege und Podeste / Bundle of ladders and platforms Faisceau d'échelles et de plates-formes / Serie di scale e rampe Paquete de escaleras y plataformas / Escadas e patamares		120 HC (132 HC)	3,50	1,20	1,00	1000	
25	1	Kiste mit Kleinteilen / Crate with small parts Caisse contenant des accessoires / Cassa con accessori Caja con accesorios / Caixa de acessórios			2,00	1,00	1,00	2000	

(\*) Angaben in Klammern gelten für 8 m-Untwagen. / The data in brackets are valid for an undercarriage of 8 m. / Les données techniques indiquées entre parenthèses sont valables pour un châssis de 8 m. / Caratteristiche in (...) valgono per carro di 8 m. / Los datos entre paréntesis son válidos para carro de 8 m. Características em (...) válidas pelo chassis de 8 m.

121 P - 3603 H1 B3 DIN 15018 • BGL 2125-0112 / FEM (Section 1) Krangruppe A3 • 03.01 / 6

Konstruktionsänderungen vorbehalten! / Subject to alterations!  
Sous réserves de modifications! / Si fa riserva di modifiche!  
Salvo modificação da construção! / Sujeito a modificaciones!

Printed in Germany.

LIEBHERR-WERK BIBERACH GMBH, Postfach 1663, D-88396 Biberach an der Riß  
T (0 73 51) 41-0, Fax (0 73 51) 41 22 25, www.lbc.liebherr.de, E-Mail: info@lbc.liebherr.com